

CertoClav Vacuum Pro Series

STERILIZATION OF LIQUIDS, SOLIDS AND WASTE

>> FOR ALL
STERILIZATION
APPLICATIONS<<



- ✓ 12 – 45 liters
- ✓ Flexible temperature sensor
- ✓ Sterilization of solids, liquids and waste
- ✓ automatic documentation
- ✓ Stand alone or fixed water connection
- ✓ Autofill



CERTOCLAV
Since 60 years.

CertoClav Vacuum Pro Series

SUITABLE FOR ANY APPLICATION

- ✓ **Microbiology, Bio-Chemistry**
Sterilize culture media precisely with the integrated media sensor
- ✓ **Food industry**
Food preservation
- ✓ **Material testing**
Perform hundreds of cycles in succession, fully automatically without user interaction
- ✓ **Pharmacy**
Sterilize hollow instruments, porous materials, packaging, plastics, rubber and textiles
- ✓ **Universities**
Robust, ideally for any application and training operation



CERTOCLAV
Since 60 years.

CertoClav Vacuum Pro Series

WITH DOCUMENTATION AND TRACING SYSTEM

AUTOMATIC DOCUMENTATION
WITH ONLINE OR OFFLINE SERVER

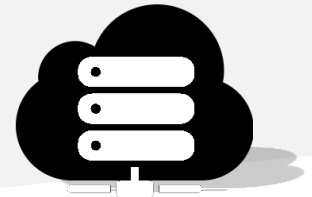
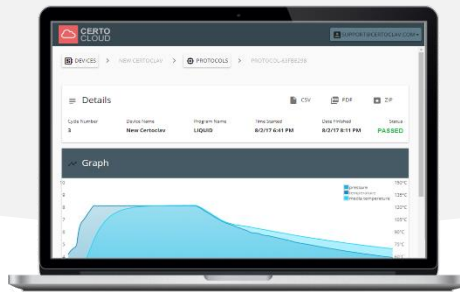

Connect the autoclave
via LAN



Connect the autoclave via
W-LAN



Receive Email
notifications



Print protocols with the
protocol printer



Label sterilized items with
tracing information



Export protocols to
USB flash drive



Export protocols to SD
CARD.



Track the complete sterilization
process via scanner.



Stand alone or fixed
water connection

CertoClav Vacuum Pro Series

STAND ALONE – OR – FIXED WATER CONNECTION

AUTOCLAVE ORDER CONFIGURATION

Order number	Chamber size: 12 liters	Chamber size: 18 liters	Chamber size: 22 liters	Chamber size: 45 liters	Internal water tanks (Stand alone)	Fixed water connection
8500487	✓				✓	
8500487W	✓					✓
8500488		✓			✓	
8500488W		✓				✓
8500489			✓		✓	
8500489W			✓			✓
8500610				✓	✓	

ACCESSORIES



Reverse osmosis system

Automatic water supply for the autoclave. Requires tap water connection. Power: 110-220V, 50-60Hz. Order number: 8500499



Filters for reverse osmosis system

Order numbers:
8500510 (Sediment filter, replace every 6 months)
8500511 (Precarbon filter, replace every 6 months)
8500512 (Membrane filter, replace every 30 months)



Label printer

Print expiration date and protocol information on self-adhesive label and mark your goods. Order number: 8500502



Barcode scanner

Track the complete sterilization history of an item. Order number: 8500503



Service sets

Includes door sealing, air filter, safety valve, quick-connect drain hose. Order number:
12l – 22l: 8500495
45l: 8500407



External printer

Print protocols with a printer. Order number: 1300187



CertoServer

The CertoServer communicates with the autoclave via network. Automatic data backups and browser-based data access. Order number: Available from June 2018



CertoCloud premium license

- Enable SMS notifications
 - Storage for 100.000 protocols
 - Premium Remote support
 - Real-time-data online
- Order number: 8500212

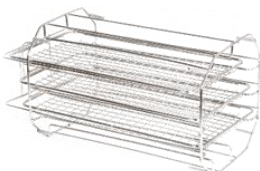

Tray set

Order number:
12l: 8500479
18l: 8500480
22l: 8500481
45l: 8500404



Wire basket

Order number:
12l: 8500401
18l: 8500402
22l: 8500403
45l: 8500406



Plate for bottles

Order number:
12l: 8500479A
18l: 8500480A
22l: 8500481A
45l: 8500404A

CertoClav Vacuum Pro Series

INTUITIVE TOUCH-SCREEN CONTROL

User management

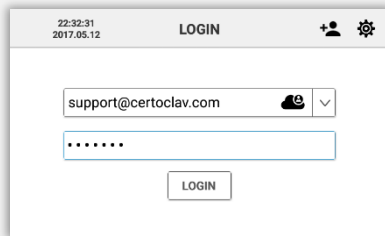

Tracing

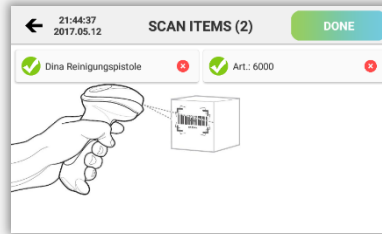

Program editor

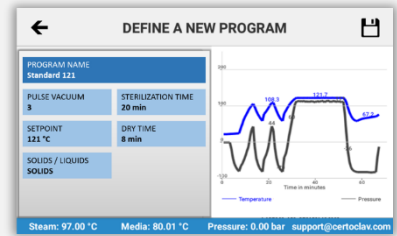

On-Screen help and support

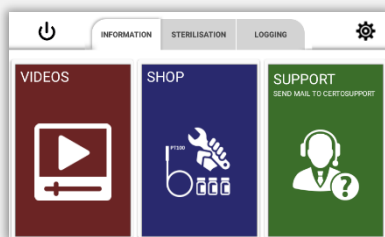

Protocol view

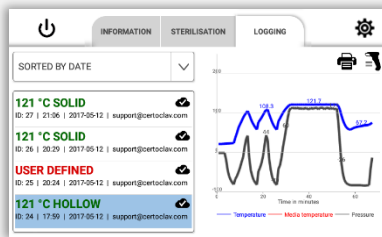

Step-by-step video assistant



CertoClav Vacuum Pro Series

INCLUDING DOCUMENTATION SOLUTION

Remote user management

Email Address *
max.muster@mail.com

Password *
.....

[Forgot Password?](#)

LOGIN

Real time data

Autoclave Lab 2

Serial: 220002576

Model: CertoClav 22 Vac Pro

Firmware: DEFAULT

SMS und email

If An Error Occured, Send Notification

SMS 0123456789

EMAIL max.muster@mail.com

PDF, Excel, CSV data export

Cycle ↑	Program Name	Start
76	cloud generated	7/22/ PM
75	121°C SOLID	7/22/ PM
74	Neues Programm	7/22/ PM
74	121°C SOLID	7/22/ PM

Graphical protocol view

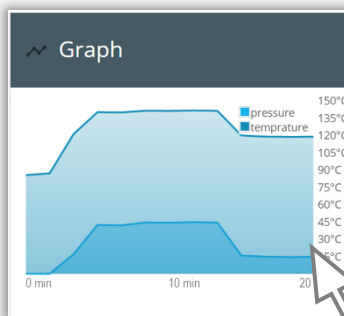

Signed PDFs

Protocol Verification

Protocol ID * 0 / 24

Device Key * 0 / 17

Security Code * 0 / 40

CERTO CLOUD SUPPORT@CERTOCLAV.COM

DEVICES > NEW CERTOCLAV > PROTOCOLS > PROTOCOL-63FBE298

Details

CSV PDF ZIP

Cycle Number	Device Name	Program Name	Time Started	Date Finished	Status
3	New CertoClav	LIQUID	8/2/17 6:41 PM	8/2/17 8:11 PM	PASSED

Graph

pressure 150°C, 135°C, 120°C, 105°C, 90°C, 75°C, 60°C

temperature

media temperature

CertoClav Vacuum Pro Series

STERILIZE SOLID MATERIALS, LIQUIDS AND WASTE

STERILIZATION OF SOLID MATERIALS

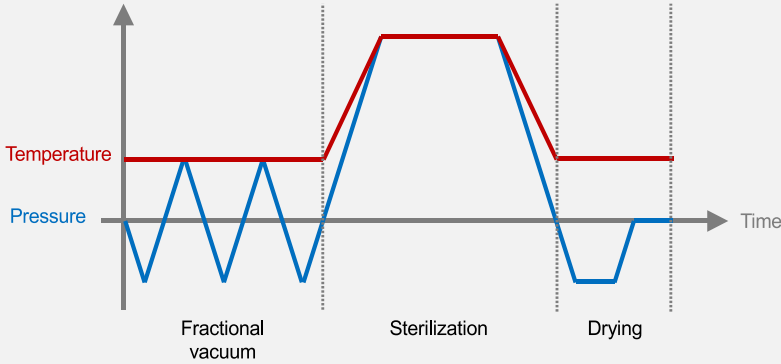

- ✓ All sterilization programs for solids follow a typical Class-B cycle.
- ✓ Precise combination of vacuum, pressure and temperature for optimal sterilization of solids.
- ✓ The fractionated vacuum presses the saturated water vapor through the sterilization package and into each microscopic gap.

STERILIZATION OF LIQUIDS WITH MEDIA SENSOR

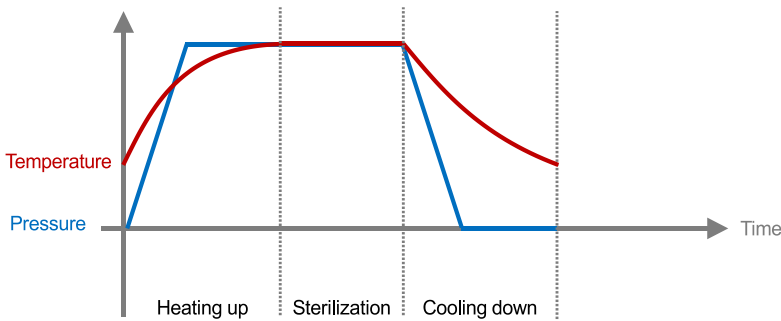

- ✓ All sterilization programs for liquids follow a heating phase with venting followed by a sterilization phase and a final cooling phase.
- ✓ Sterilization of liquids at 121°C for 20 minutes.
- ✓ The integrated flexible temperature sensor measures the real temperature of liquids and ensures an optimum sterilization result.

STERILIZEABLE MATERIALS



Instruments



Unpacked materials, single and double packed instruments



Liquids in bottles



Liquids with media temperature sensor



Foodstuffs



Textiles

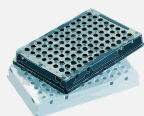

Plastics, rubber materials



Porous materials, sand



Hollow materials



Filters, waste

CertoClav Vacuum Pro Series

CUSTOM PROGRAM AND AUTOMATED MATERIAL TESTS

PROGRAMS

	Vacuum times	Temperature [°C]	Holding time [min]	Drying time [min]	Total time [min]
Solid	1	121	20	3	32
Solid quick*	1	134	4	3	20
Porous	3	121	20	7	50
Porous quick*	3	134	4	7	27
Hollow	3	121	20	10	47
Hollow quick*	3	134	4	10	34
Liquid	0	105 to 134	1 to 60	0	45 to 180
Prion*	3	134	20	10	50
B-D test	3	134	4	7	31
Vacuum test	1	-	15	-	15
Clean process*	-	-	-	-	29
User-Defined*	1 to 10	105 to 134	1 to 60	1 to 40	

*Default programs only available for Vacuum Pro 12L – 22L. However, all programs are customizable by the user

MATERIAL TESTS

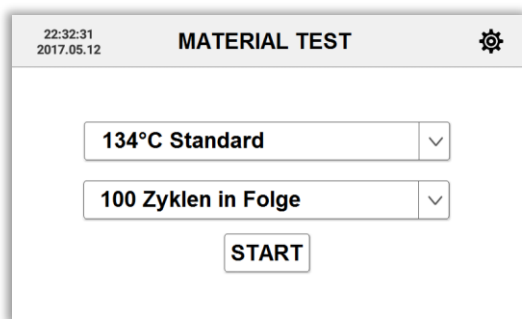

- Set repeat function for material tests
- Each sterilization program can be executed as often as desired
- Watch real-time-data on www.certocloud.com
- Receive a notification, after the material test has been finished



CertoClav Vacuum Pro 12L - 22L



CertoClav Vacuum Pro 45L

CertoClav Vacuum Pro Series

THE ALL-IN-ONE AUTOCLAVE

TECHNICAL DATA



Chamber volume	12 liter	18 liter	22 liter	45 liter
Product category	Tabletop autoclave	Tabletop autoclave	Tabletop autoclave	Tabletop autoclave
Order number of autoclave with integrated water tanks	8500487	8500488	8500489	8500610
Order number for autoclave with fixed water connection.	8500487W	8500488W	8500489W	-
Integrated, from chamber separated steam generator	✓	✓	✓	✓
Temperature and pressure up to 136°C, 3.2 bar	✓	✓	✓	✓
Touchscreen and full automatic microcontroller control	✓	✓	✓	✓
Number of sterilization programs	12 user customizable	12 user customizable	12 user customizable	8 user customizable
User account management	✓	✓	✓	✓
Internal storage for 10.000 sterilization records and export feature to PC	✓	✓	✓	✓
Vacuum system for sterilization of solids and waste in bags	✓	✓	✓	✓
Steam exhaust filter for sterilization of biological hazardous substances	Optional	optional	optional	optional
Flexible temperature sensor	✓	✓	✓	✓
Interfaces for record of sterilization records	Protocol printer, USB, RS232, RS485 and SD-card			
Interfaces for tracing	Barcode scanner and label printer			
Network enabled with Ethernet and WLAN	✓	✓	✓	✓
Automatic water quality monitoring	✓	✓	✓	✓
CertoTrace Software enabling simple tracing across the whole decontamination process	✓	✓	✓	✓
CertoCloud documentation software for full automatic data backups to offline or local server	✓	✓	✓	✓
Product size	61 x 50 x 43 cm	61 x 50 x 43 cm	65 x 50 x 43 cm	84 x 64 x 56 x cm
Diameter of chamber	20 cm	25 cm	25 cm	31.9 cm
Depth of chamber	36 cm	35 cm	45 cm	61.7 cm
Net weight	51 kg	53 kg	55 kg	120 kg
Gross weight	59 kg	61 kg	63 kg	131 kg
Carton size	73 x 57 x 51 cm	73 x 57 x 51 cm	77 x 57 x 51 cm	90 cm x 75 cm x 70 cm
Scope of delivery	1 autoclave, 3 trays, 1 tray holder, 1 tray handle, 1 power cable, 1 quick-connect drain hoses, 1 CertoCloud license			
Sterilizable materials	Solids, hollow materials, porous materials, liquids, prions, textiles, plastics			
Locking mechanism	Electric door lock	Electric door lock	Electric door lock	Electric door lock
Screen	7" Touch screen	7" Touch screen	7" Touch screen	7" Touch screen
Chamber material	Stainless steel 304	Stainless steel 304	Stainless steel 304	Stainless steel 304
Languages	English, German	English, German	English, German	English, German
Sterilization temperature	105°C to 136°C	105°C to 136°C	105°C to 136°C	105°C to 136°C
Maximum working pressure	230 kPa	230 kPa	230 kPa	230 kPa
Power supply	220V, 50/60Hz, 2400W	220V, 50/60Hz, 2400W	220V, 50/60Hz, 2400W	220V, 50/60Hz, 2400W
Certification	CE	CE	CE	CE
Warranty	2 years	2 years	2 years	2 years



CertoClav Sterilizer GmbH
Georg Grinninger-Str. 37
A-4050 Traun



Phone: +437229689
Email: support@certoclav.com
Website: www.certoclav.com



Orders, dealer verification
Custom manufacture
Operating instructions and operation videos
Technical support

Loading Capacity CertoClav Vacuum Pro 45L



Tray Set

Order number: 8500404

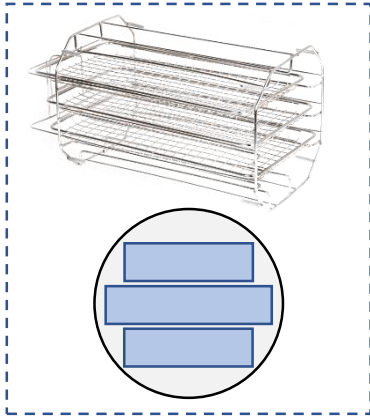

Basket

Order number: 8500406

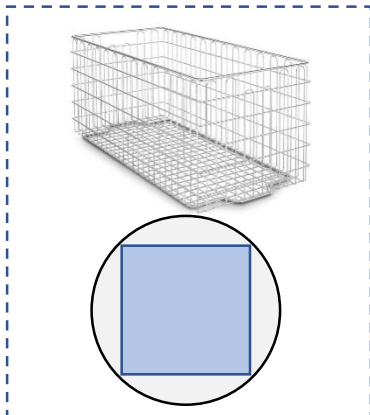

Bottle Plate

Order number: 8500404A

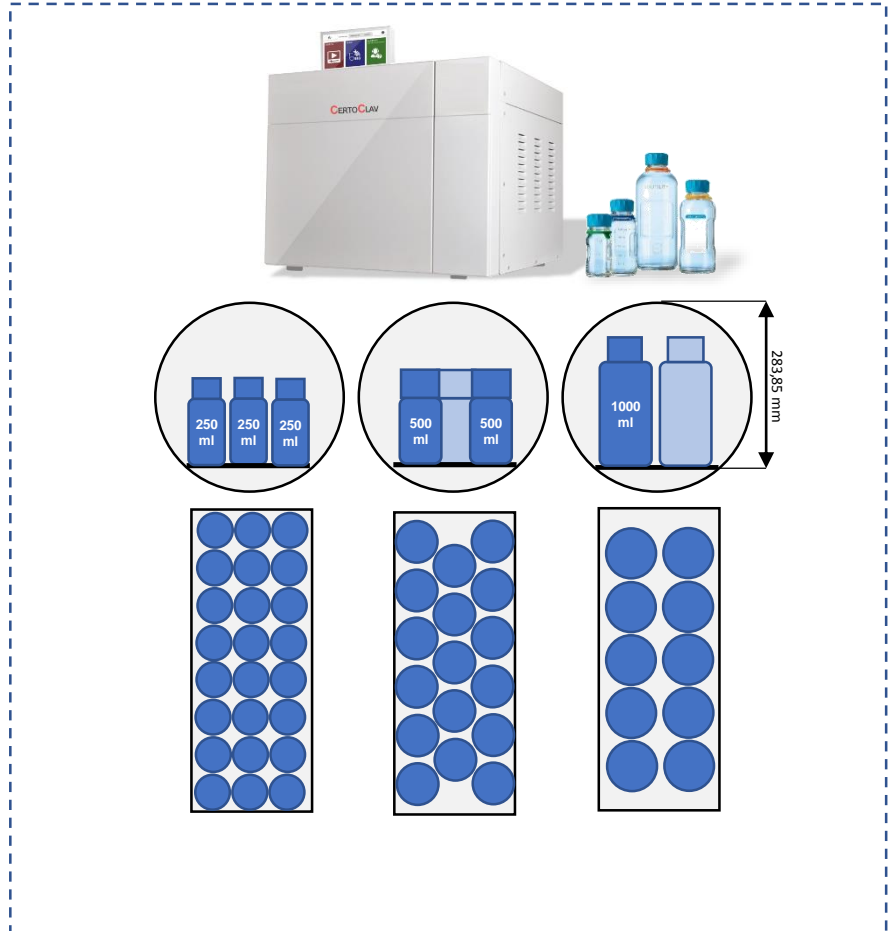

Article	Number	Width [mm]	Height [mm]	Length [mm]	Quantity
Tray Set	8500481	170	50	430	2
		220	50	430	1
Bottle Plate	8500481A	160	2	400	1
Waste Basket	8500481B	170	170	410	1

Article	Number	Volume [ml]	Height [mm]	Diameter [mm]	Capacity VAC PRO 45L	Capacity VAC PRO 22L	Capacity VAC PRO 18L	Capacity VAC PRO 12L
Duran Bottle	218812854	125	124	55	150	17	14	11
Duran Bottle	218813653	250	158	66	25	10	8	7
Duran Bottle	218814452	500	193	78	17	8	6	0
Duran Bottle	218815457	1000	253	93	10	0	0	0



CertoClav Sterilizer GmbH
Georg Grinninger-Str. 37
A-4050 Traun



Tel: +437229689
E-Mail: support@certoClav.com
Website: www.certoClav.com



Bestellungen, Händlerverifizierung
Sonderanfertigungen
Bedienungsanleitungen und Bedienungsvideos
Technischer Support

Loading Capacity CertoClav Vacuum Pro 22L



Tray Set
Order number: 8500481

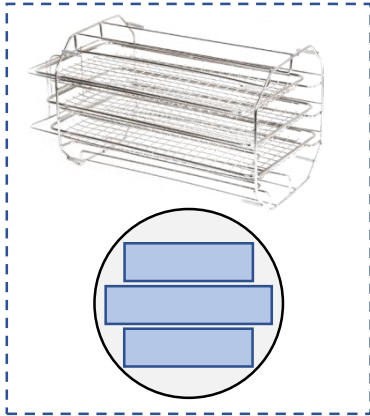

Bottle Plate
Order number: 8500481A

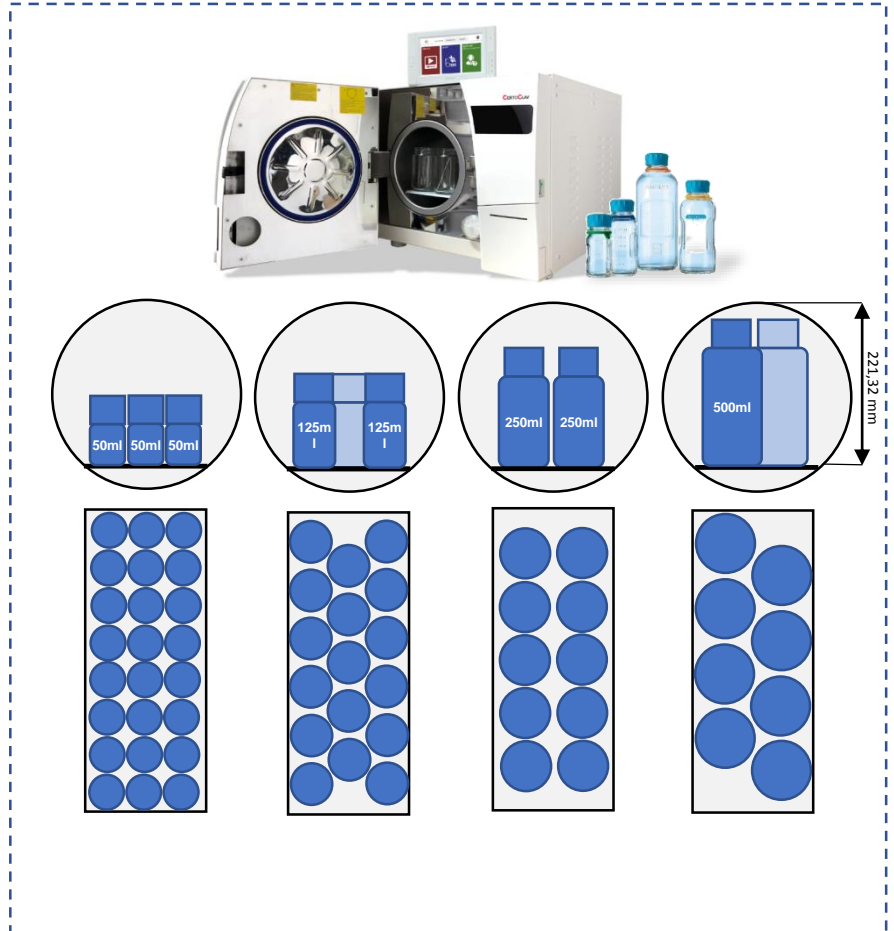

Tray Set
Order number: 8500403

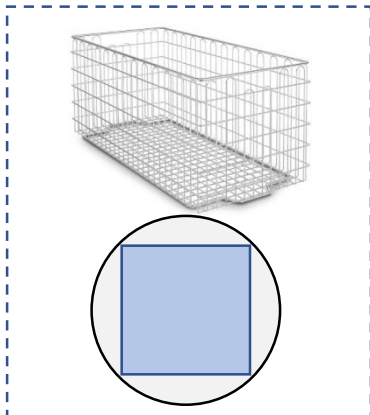

Article	Number	Width [mm]	Height [mm]	Length [mm]	Quantity
Tray Set	8500481	170	50	430	2
		220	50	430	1
Bottle Plate	8500481A	160	2	400	1
Waste Basket	8500481B	170	170	410	1

Article	Number	Volume [ml]	Height [mm]	Diameter [mm]	Capacity VAC PRO 22L	Capacity VAC PRO 18L	Capacity VAC PRO 12L	Capacity VAC PRO 8L
Duran Bottle	21801175	50	91	46	24	18	16	12
Duran Bottle	218812854	125	124	55	17	14	11	9
Duran Bottle	218813653	250	158	66	10	8	7	0
Duran Bottle	218814452	500	193	78	8	6	0	0



CertoClav Sterilizer GmbH
Georg Grinninger-Str. 37
A-4050 Traun



Tel: +437229689
E-Mail: support@certoClav.com
Website: www.certoClav.com



Bestellungen, Händlerverifizierung
Sonderanfertigungen
Bedienungsanleitungen und Bedienungsvideos
Technischer Support

Loading Capacity CertoClav Vacuum Pro 18L



Tray Set
Order number: 8500480

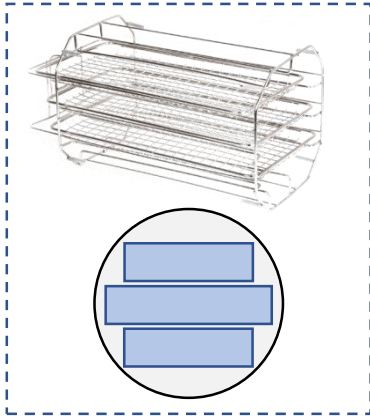

Bottle Plate
Order number: 8500480A

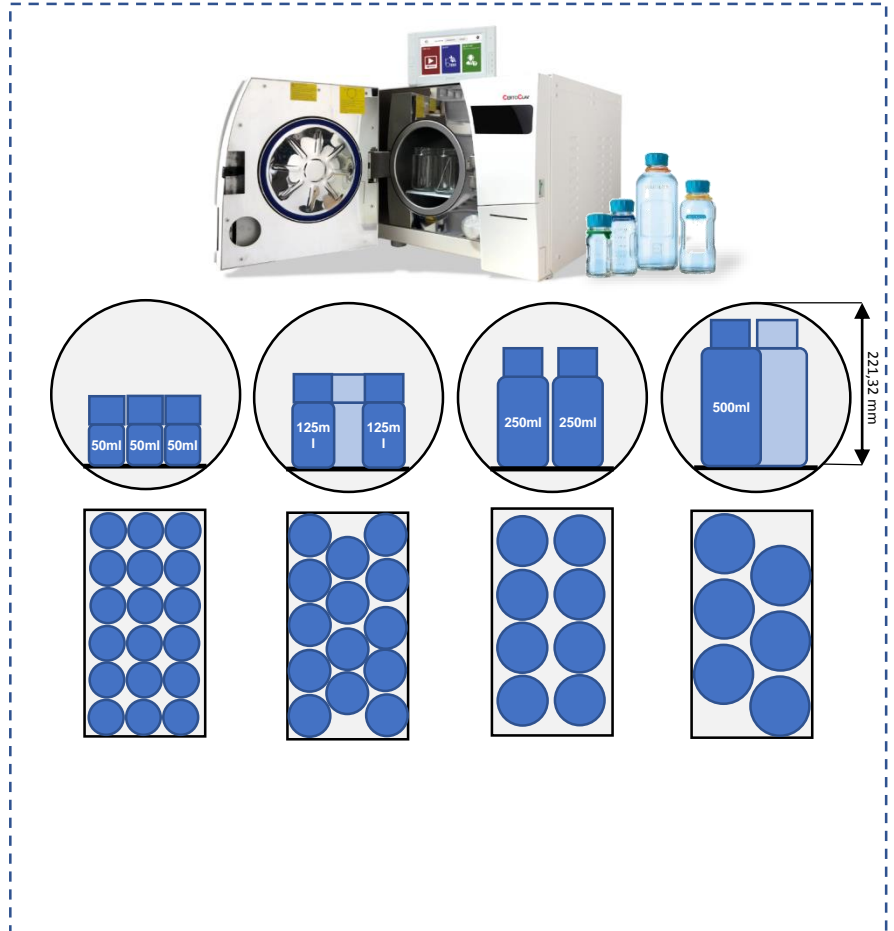

Tray Set
Order number: 8500402

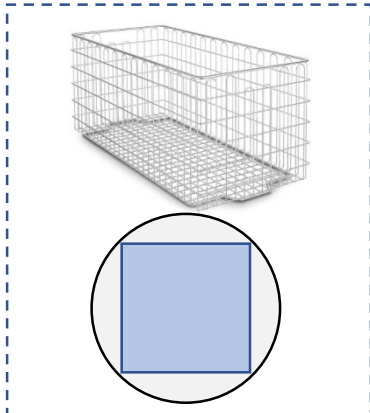

Article	Number	Width [mm]	Height [mm]	Length [mm]	Quantity
Tray Set	8500480	170	50	330	2
		220	50	330	1
Bottle Plate	8500480A	160	2	300	1
Waste Basket	8500490B	170	170	310	1

Article	Number	Volume [ml]	Height [mm]	Diameter [mm]	Capacity VAC PRO 22L	Capacity VAC PRO 18L	Capacity VAC PRO 12L	Capacity VAC PRO 8L
Duran Bottle	21801175	50	91	46	24	18	16	12
Duran Bottle	218812854	125	124	55	17	14	11	9
Duran Bottle	218813653	250	158	66	10	8	7	0
Duran Bottle	218814452	500	193	78	8	6	0	0



CertoClav Sterilizer GmbH
Georg Grinninger-Str. 37
A-4050 Traun



Tel: +437229689
E-Mail: support@certoClav.com
Website: www.certoClav.com



Bestellungen, Händlerverifizierung
Sonderanfertigungen
Bedienungsanleitungen und Bedienungsvideos
Technischer Support

Loading Capacity CertoClav Vacuum Pro 12L



Tray Set

Order number: 8500479

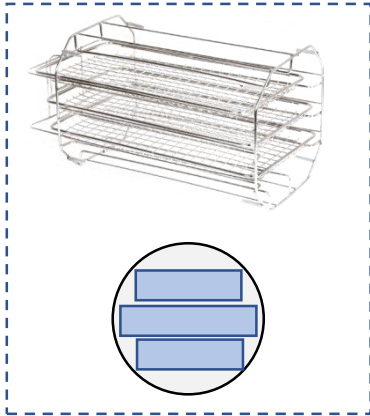

Tray Set

Order number: 8500401

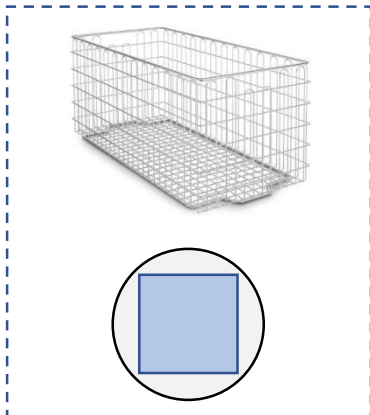

Bottle Plate

Order number: 8500479A

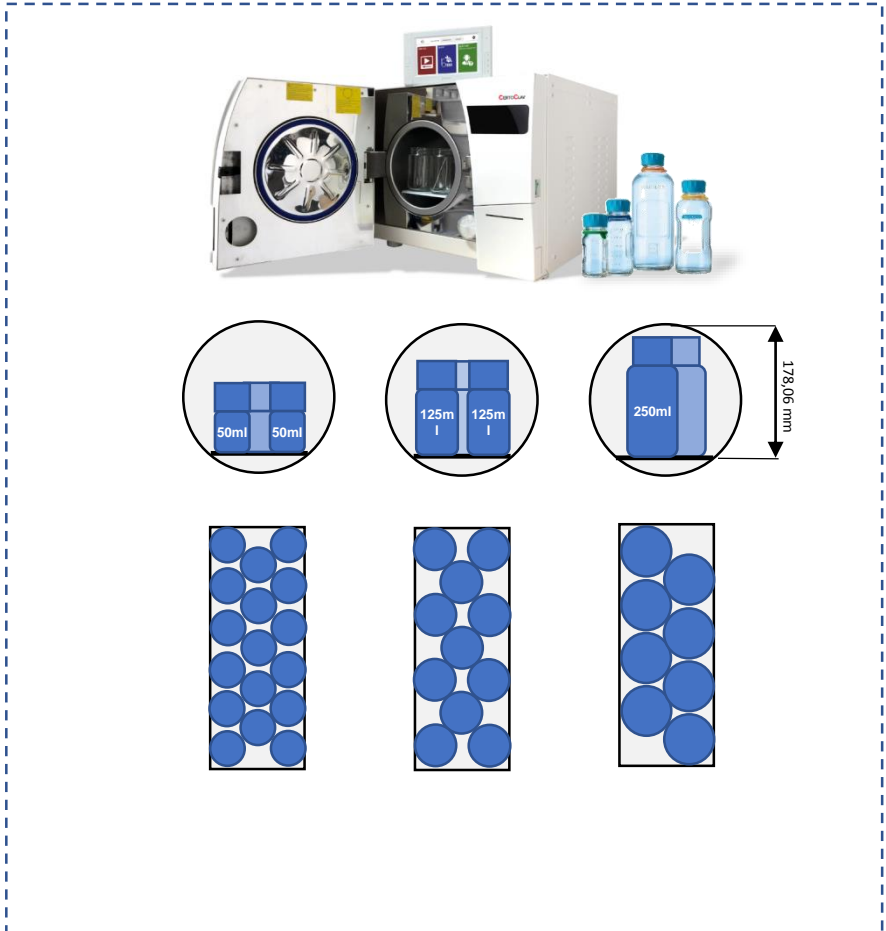

Article	Number	Width [mm]	Height [mm]	Length [mm]	Quantity
Tray Set	8500479	140	40	340	2
		180	40	340	1
Bottle Plate	8500479A	125	2	320	1
Waste Basket	8500479B	135	135	320	1

Article	Number	Volume [ml]	Height [mm]	Diameter [mm]	Capacity VAC PRO 22L	Capacity VAC PRO 18L	Capacity VAC PRO 12L	Capacity VAC PRO 8L
Duran Bottle	21801175	50	91	46	24	18	16	12
Duran Bottle	218812854	125	124	55	17	14	11	9
Duran Bottle	218813653	250	158	66	10	8	7	0
Duran Bottle	218814452	500	193	78	8	6	0	0



CertoClav Sterilizer GmbH
Georg Grinninger-Str. 37
A-4050 Traun



Tel: +437229689
E-Mail: support@certoClav.com
Website: www.certoClav.com



Bestellungen, Händlerverifizierung
Sonderanfertigungen
Bedienungsanleitungen und Bedienungsvideos
Technischer Support